



Pompom met pet

De heppiepet ► diverse activiteiten





Schatkistkaarten SE emoties

De heppiepet ► Diverse activiteiten



SE

emoties
zelfbeeld en persoonlijke ontwikkeling

1

emoties
zelfbeeld en persoonlijke ontwikkeling

Schatkist editie 3 • Illustrator: Uco Egmond • © 2015 Uitgeverij Zwijsen B.V., Tilburg



blij

SE

emoties
zelfbeeld en persoonlijke ontwikkeling

2

Schatkist editie 3 • Illustrator: Uco Egmond • © 2015 Uitgeverij Zwijsen B.V., Tilburg



boos



Schatkistkaarten SE emoties

De heppiepet ▶ Diverse activiteiten

SE

emoties
zelfbeeld en persoonlijke ontwikkeling

3

emoties
zelfbeeld en persoonlijke ontwikkeling

Schatkist editie 3 • Illustrator: Uco Egmond • © 2015 Uitgeverij Zwijsen B.V., Tilburg

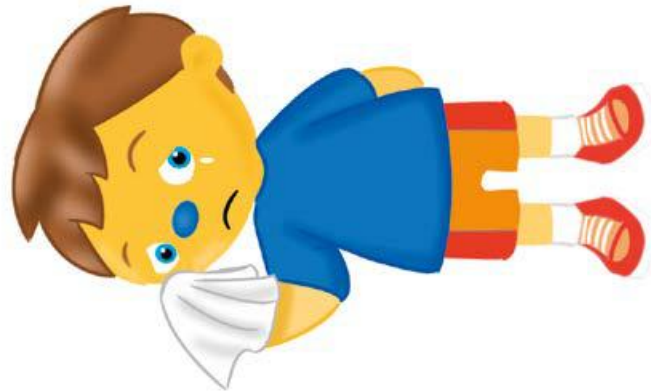

verdrietig

SE

emoties
zelfbeeld en persoonlijke ontwikkeling

4

emoties
zelfbeeld en persoonlijke ontwikkeling

Schatkist editie 3 • Illustrator: Uco Egmond • © 2015 Uitgeverij Zwijsen B.V., Tilburg



verlegen



Voorbeelden van verdriet

De heppiepet ▶ Een pet om vrolijk van te worden



mijn speelgoed is stuk.



ik heb pijn.



iemand pakt mijn speelgoed af.

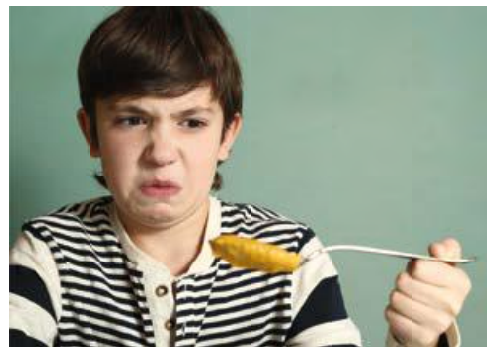

ik lust het eten niet.



ik ben bang in bed.



iemand heeft me pijn gedaan.



ik voel me ziek.



ik wil niet dat je weg gaat.



Preteachingplaat

De heppiepet ► Wat heb jij op je hoofd?





De heppiepet

1 Reteke-reteketet,
Ken je de heppiepet?
Het is geen dokter groot of klein,
en ook geen medicijn
Maar vrolijk is het wel
dit deksel op mijn hoofd
Het is de heppiepet.
zet hem op en het wordt pret.

Refrein Zwaai met je pet 'goeiedag'.
Buig met je pet,
je heppiepet.
Want voor een lach
ga je door je knieën.

De heppie heppiepet is cool,
ze geeft je weer een goed gevoel.
De pijn vergeet je,
dat helpt een beetje
Ahaaaaa ...

2 Kriebel hier, kriebel daar,
als je ziek bent, doe ik raar.
Dan heb ik maar één doel:
pomp je vol met goed gevoel.
Gekke pet van mij
maak mijn mama blij.
Kijk wat zie ik daar,
die mooie lach van haar.

Refrein

3 Ikke hikke ik
oh nu heb ik de hik.
Mijn oortjes voelen warm
en mijn buikje slaat alarm
Ik dans de pijntjes weg.
Heppie heppiepet,
jij bent hier bij mij
en dat maakt me reuzeblij.

Refrein (2x)
2^{de} keer

Zwaai met je pet 'goeiedag'.
Buig met je pet,
je heppiepet.
Want voor een lach
ga je door je knieën.

De heppie heppiepet is cool,
ze geeft je weer een goed gevoel.
Ik zorg voor jou
en jij voor mij
Ahaaaaa ...



Schatkistkaarten T vraagkaarten

De heppiepet ▶ Diverse activiteiten



T

vraagkaarten
verhaaloriëntatie en verhaalbegrip

1

Dag Loelel • ©2016 Uitgeverij Zwijsen België, Antwerpen



wie?

T

vraagkaarten
verhaaloriëntatie en verhaalbegrip

2

Dag Loelel • ©2016 Uitgeverij Zwijsen België, Antwerpen

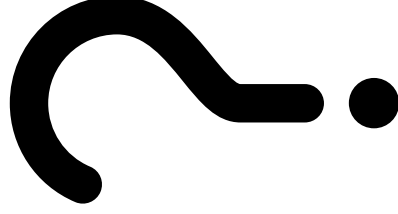

wat?



Schatkistkaarten T vraagkaarten

De heppiepet ▶ Diverse activiteiten



T

vraagkaarten
verhaaloriëntatie en verhaalbegrip

3

Dag Loelel • ©2016 Uitgeverij Zwijsen België, Antwerpen

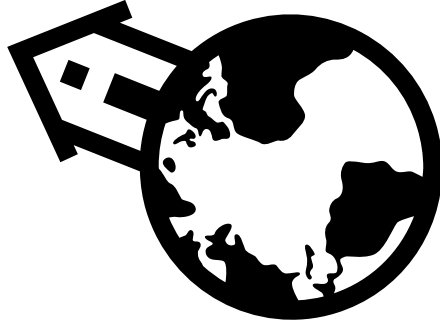

waar?

T

vraagkaarten
verhaaloriëntatie en verhaalbegrip

4

Dag Loelel • ©2016 Uitgeverij Zwijsen België, Antwerpen

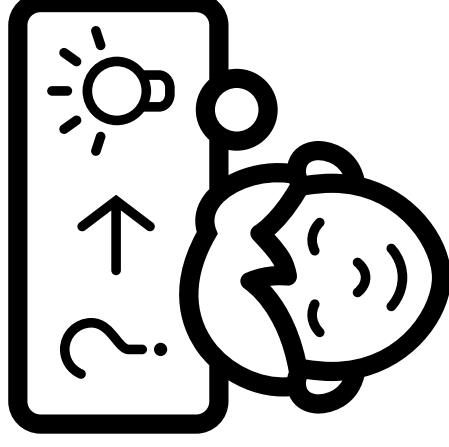

hoe?



Schatkistkaarten WT ontwerpstappen

De heppiepet ► Diverse activiteiten



WT

ontwerpstappen
vaardigheden

1

Schatkist editie 3 • Uco Egmond • © 2015 Uitgeverij Zwijsen B.V., Tilburg



wat is het probleem?

WT

ontwerpstappen
vaardigheden

2

Schatkist editie 3 • Uco Egmond • © 2015 Uitgeverij Zwijsen B.V., Tilburg



bedenk een oplossing; wat weet je al?



Schatkistkaarten WT ontwerpstappen

De heppiepet ► Diverse activiteiten

WT

ontwerpstappen
vaardigheden

3

Schatkist editie 3 • Uco Egmond • © 2015 Uitgeverij Zwijsen B.V., Tilburg



maak wat je bedacht hebt.

WT

ontwerpstappen
vaardigheden

4

Schatkist editie 3 • Uco Egmond • © 2015 Uitgeverij Zwijsen B.V., Tilburg



werkt het, wat je bedacht hebt?



Schatkistkaarten WT ontwerpstappen

De heppiepet ▶ Diverse activiteiten



WT

ontwerpstappen
vaardigheden

5

Schatkist: editie 3 • Uco Egmond • © 2015 Uitgeverij Zwijsen B.V., Tilburg



kun je het nog verbeteren?



Een plan voor een pet

De heppiepet ► diverse activiteiten

_____ maakt een pet voor _____

wie?



kleur?



_____ houdt van:





Een e-mail van Tim

De heppiepet ► In het ziekenhuis ...

Hallo kinderen

Wat fijn om te horen dat jullie ook heppiepetten gaan maken.

Mijn mama heeft de heppiepet die ze van Pompom heeft gekregen bijna elke dag op. Dat is zo'n vrolijk gezicht, daar krijg ik dan ook weer een blij gevoel van.

Mijn mama is gisteren weer in het ziekenhuis geweest. De dokter zegt dat het goed gaat met haar behandeling dus dat is fijn nieuws. Mama wil jullie laten zien hoe ze haar ziekte in het ziekenhuis behandelen. Daarom heeft ze gisteren wat foto's voor jullie gemaakt. Ze heeft ook aan een paar andere patiënten uit het ziekenhuis gevraagd of ze van hen een foto mocht nemen. Kijken jullie even mee? Op de foto's zul je zien dat er een heleboel dingen kunnen worden gedaan om iemand beter te maken.

Sturen jullie me nog een foto van de heppiepetten wanneer ze klaar zijn? Ik denk dat mijn mama daar erg vrolijk van wordt!

Groetjes van Tim



de pleister



het infuus



het drankje



de pil



de operatie



kaal



moe



misselijk



het ziekenhuis



de bestraling



de spuit



de dokter



het kaartje



het beertje



knuffelen



het kusje

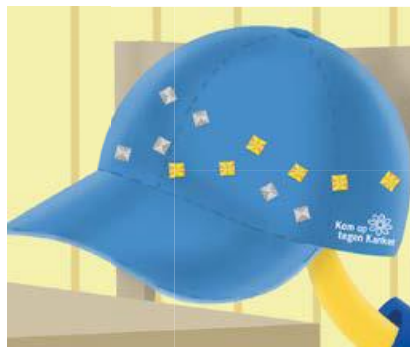

de heppiepet



het cadeau



de tekening



bezoeken



de ruiker bloemen



het knutselwerk



de brief

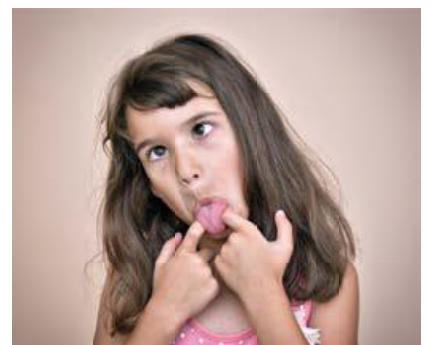

de gekke bek



Een pet van papier

De heppiepet ▶ Maak je eigen heppiepet

De voorkant

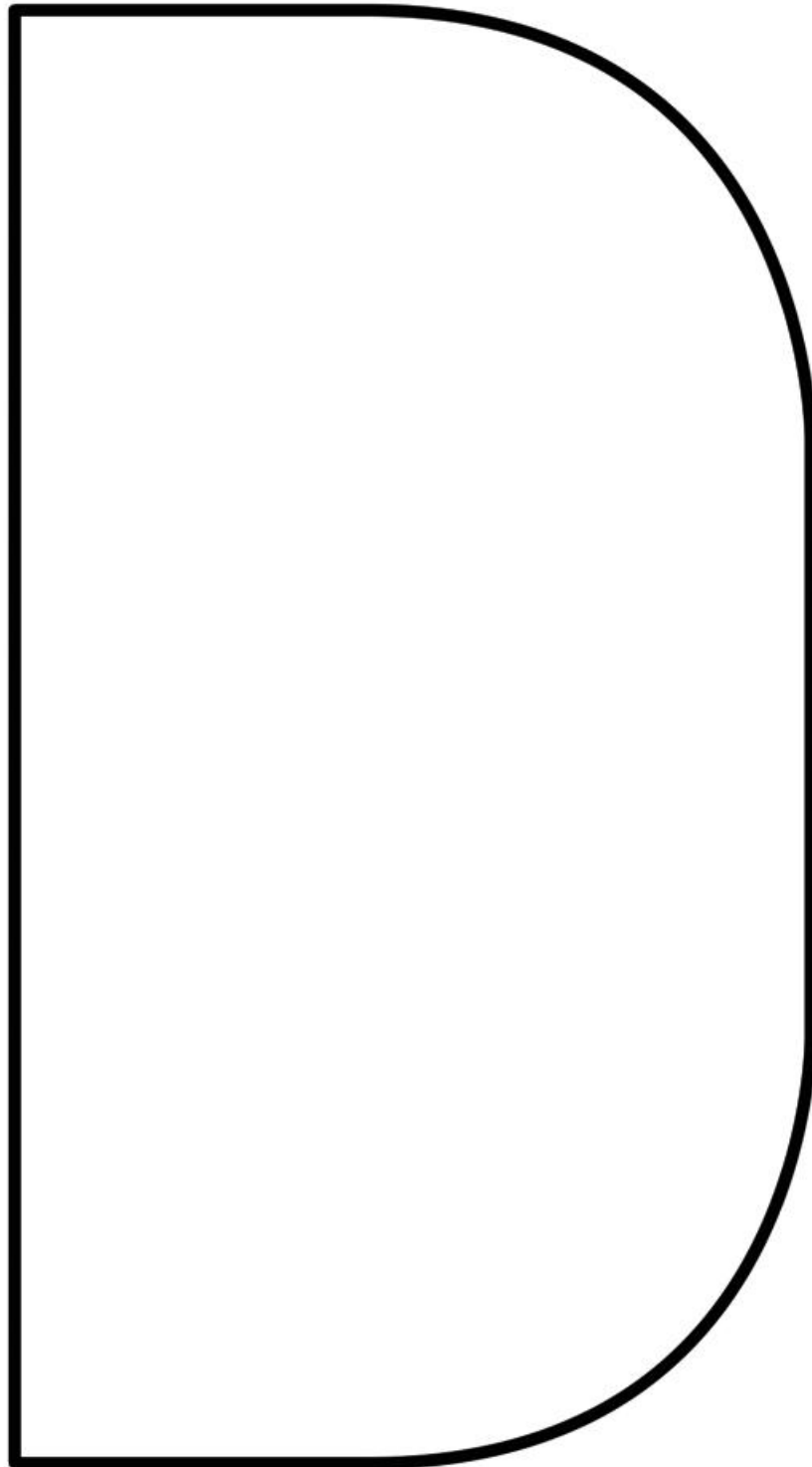



Een pet van papier

De heppiepet ▶ Maak je eigen heppiepet

De klep

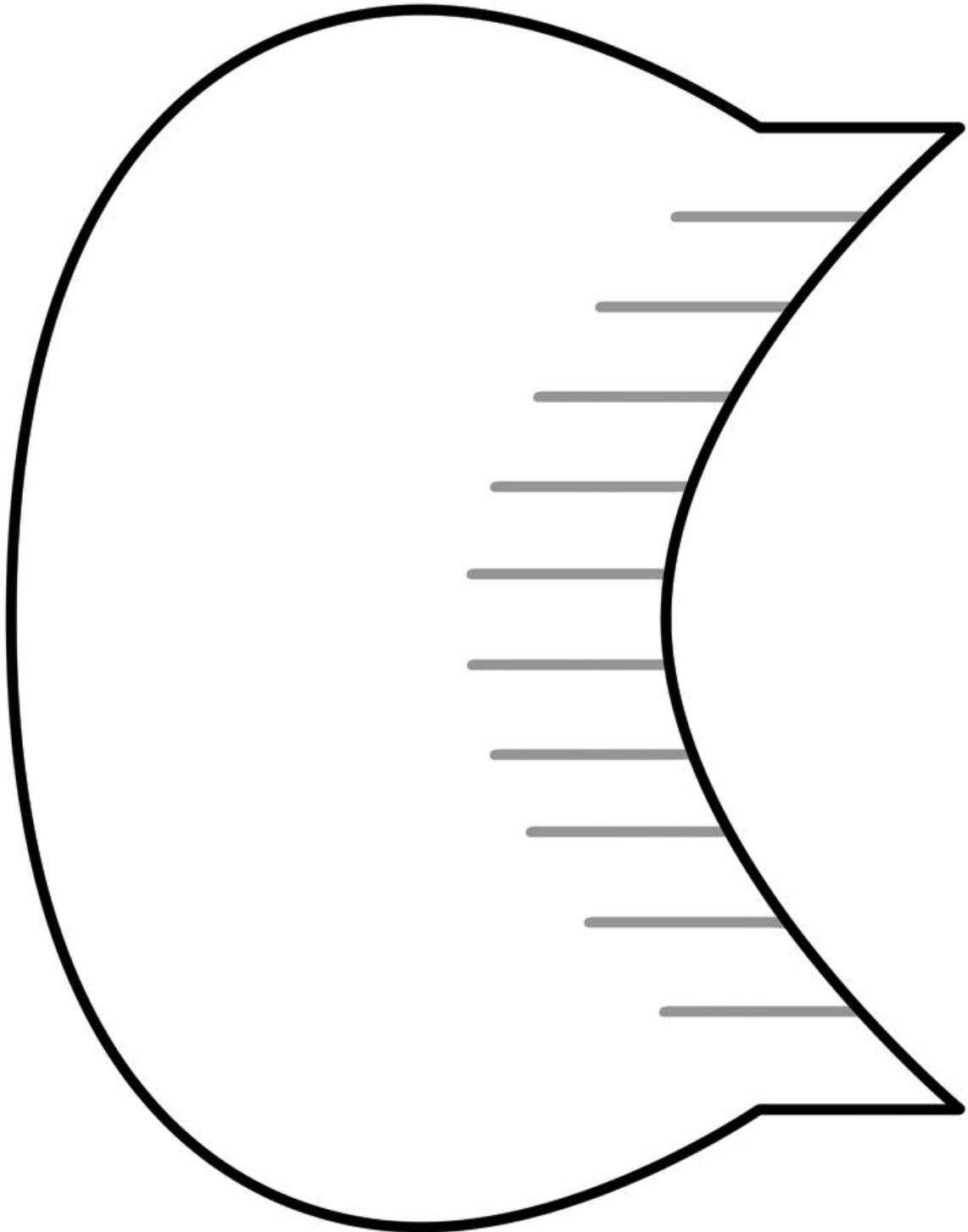



Stappenplan

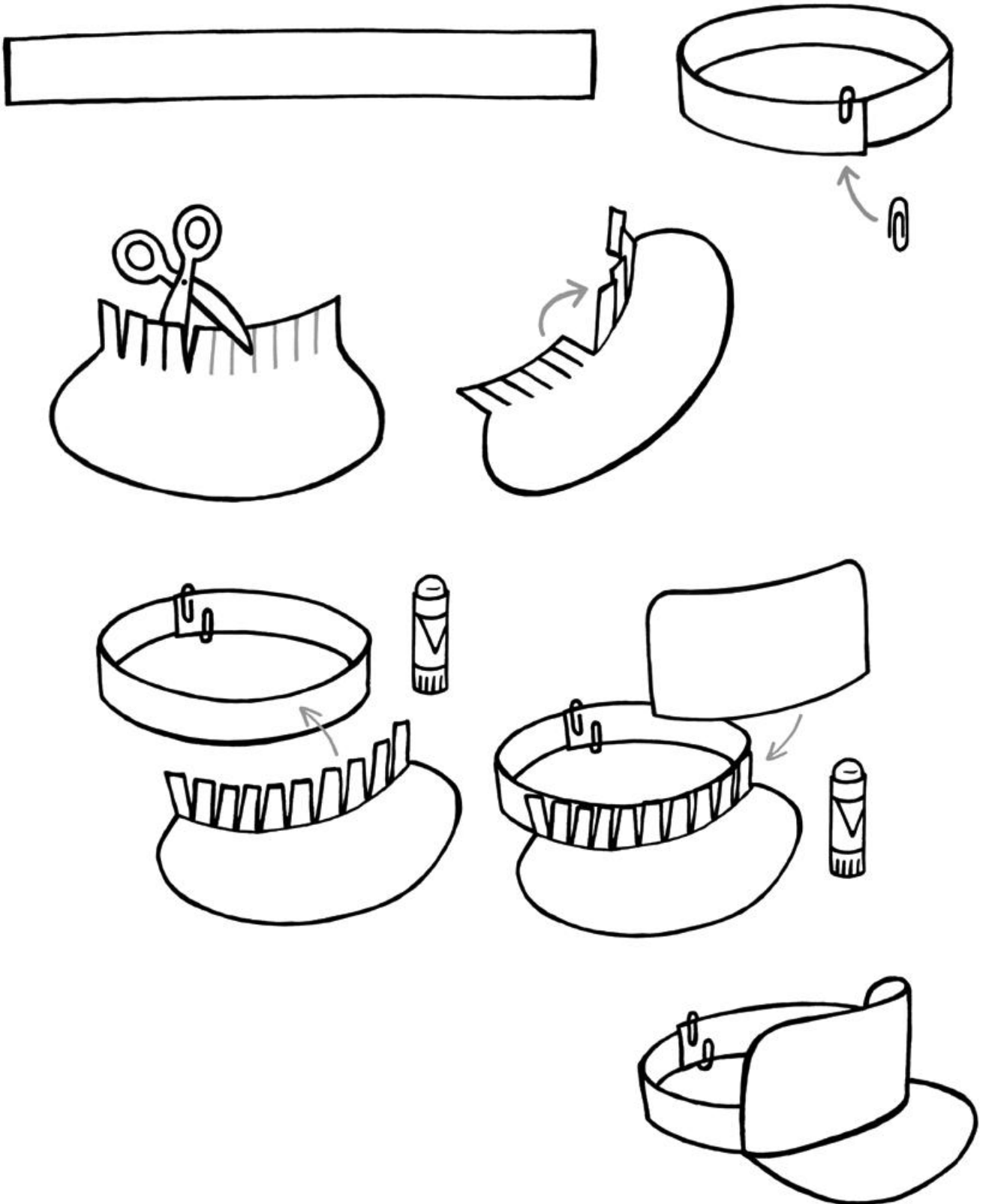



De heppiepet, plaat 1 | DE VERHALENSLEUTEL

Kom op
tegen kanker





De heppiepet, plaat 2 | DE VERHALENSLEUTEL

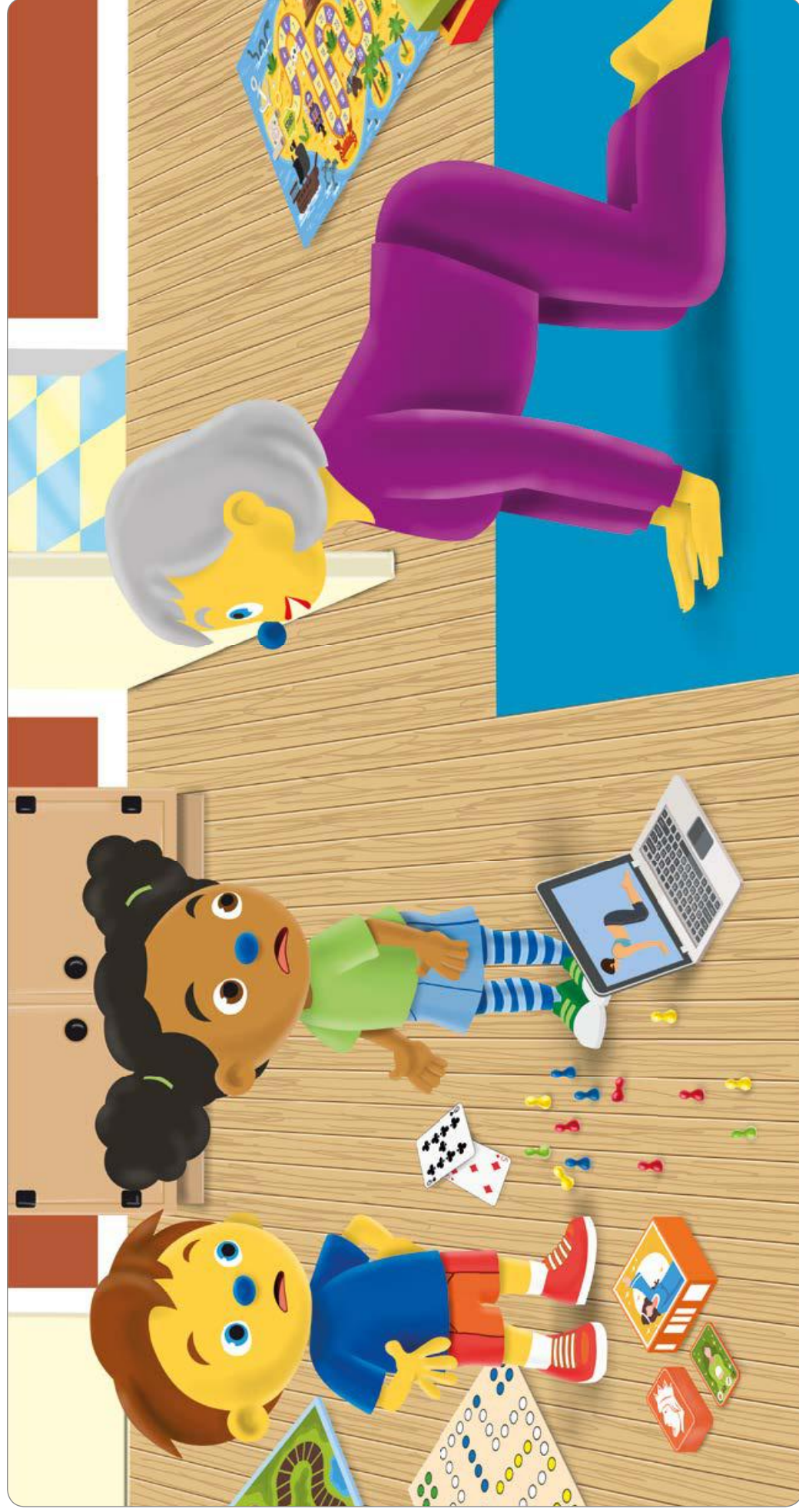



De heppiepet, plaat 3 | DE VERHALENSLEUTEL

Kom op
tegen kanker





De heppiepet, plaat 4 | DE VERHALENSLEUTEL





De heppiepet, plaat 5 | DE VERHALENSLEUTEL





De heppiepet, plaat 6 | DE VERHALENSLEUTEL

Kom op
tegen kanker





De heppiepet, plaat 7 | DE VERHALENSLEUTEL





De heppiepet, plaat 9 | DE VERHALENSLEUTEL

Kom op
tegen kanker





De heppiepet, plaait 10 | DE VERHALENSLEUTEL





De heppiepet, plaat 11 | DE VERHALENSLEUTEL





De heppiepet, plaat 12 | DE VERHALENSLEUTEL

Kom op
tegen kanker





Scorekaart met smileys

De heppiepet ▶ Passen maar!

teken de hoed.	